



Korea Internet Neutral eXchange

KINX, Inc.
We offers Neutral Internet infrastructure services



I'm good really, just a bit moody. I live it out some and all day
around, but some days the just need to be some day of working. Oh, how
a different perspective. When you're a bit more out of control and
expectation some times I use that feeling and it really scares me. I've
there isn't anything else. I know that all the people need to make it out
all these connections before they get out this one. Do you know what
mean?
Then some thing will make me laugh on that, but myself involved in
something and I feel better.

at these com-
mean?

Contents

I. Company Overview

II. Service Overview

III. Service Description

IV. Business Strategy Direction

※ The Q & A will be conducted after the presentation of contents for efficient progress.
Please write down your questions and we will provide answers after the presentation.

KINX is the only neutral IX in Korea that was established for a better interconnection between ISPs. KINX has been growing by providing **total internet infrastructure services such as neutral IDC, Internet Network, CDN, Cloud, etc.**, starting with the Internet eXchange (IX) services provided to major ISP, CP, CLOUD, CDN operators, Multiple System Operator (MSO), and government agencies at home and abroad.

Company Name	KINX, Inc. (Korea Internet Neutral eXchange)
Established Date	June 17, 2000
CEO	Jee Wook Kim
Type of Business	IDC (Internet Data Center), IX (Internet eXchange), etc.
Head Office Location	21F, Gangnam Building, 396, Seocho-daero, Seocho-gu, Seoul, KOREA
Branch Office Location	5F, Daelim Acrotel, 13, Eonju-ro 30-gil, Gangnam-gu, Seoul, KOREA (IDC Dogok Center)
Scale (as of 2019)	Revenue: 64.6 billion(consolidated), Number of employees: 130, Medium business
Home page	http://www.kinx.net

Major History

I. Company Overview

- 1998. 7. Local ISPs held meeting to solve Internet interconnection problems
- 1999. 6. KINX Management Center Opening (16 ISP representatives attend)
- 2000. 6. **Establishment of KINX Inc.**
- 2001. 4. Expansion of KINX Network Main Center (located in Dogok-dong)
- 2002. 2. Foundation of the Korea IX Association (KIXA)
 - 11. Approval of establishment of KINX Enterprise Affiliated Research Lab
- 2003. 9. Interconnection with Yahoo.com IX
- 2004. 7. Interconnection with NCA(National Computerization Agency)
 - 10. Received Appreciation Plaque and Education Human Resource General & EBS Scholastic Test Vice President Award
- 2005.10. Received Korea Expert Business Grand Prize in IX category (Sponsored by Hankook Ilbo)
- 2006. 5. Interconnection contract with NHN, leading portal site in Korea
 - 7. Selected as supervisor for the KISA eNum demonstration service business development
- 2007. 7. **A management takeover (Gabia inc.)**
 - 11. Acquired Technology innovation type SME Certification (The Ministry of SMEs and Startups)
 - 12. The 6th Information Protection Grand Prize Special Award (Ministry of Science and ICT)
- 2008. 1. Provided interconnection service to National Information Resources Service (NIRS) (Daejeon/ Gwangju Center)
 - 2. Signed MOU for kr name server management (NIDA-National Internet Development Agency of Korea)
- 2009. 3. Formed partnership with UK Xconnect Company to provide VoIP-IX service
 - 6. Received UK GTB Innovation Award
- 2010. 1. Interconnection with Telkom Indonesia IX
 - 4. Interconnection with Microsoft
- 2011. 2. **Listed on KOSDAQ**
 - 9. Acquired PEOPLE CONNECT Inc.
- 2012. 8. Acquired NOWCOM CDN Division
 - 9. Launched Cloud Service (IXcloud)
- 2013. 4. Established Hong Kong PoP
- 2014. 3. Interconnection with Daum-Kakao
 - 12. Acquired family-friendly company certification/Awarded excellent family-friendly company from Ministry of Gender Equality & Family
- 2015. 6. Launched K-CLEAN service (anti-DDoS attack system)
 - 8. Made a contract for providing CDN service to KERIS (Korea Education and Research Information Service)
 - 8. Launched China Direct Connect (CDC)
 - 11. Awarded 'SMB of ICT developmental merit' from Ministry of Science and ICT
 - 11. Cloud service accredited by KACI
 - 12. Special Award in Internet Business from 10th 'K-ICT Korea Internet Award'
- 2016. 1. Provided 'AWS Direct Connect' location (First in Korea, 24th in the world)
 - 11. Selected as an excellent service company of '2016 K-ICT Cloud Award' (Ministry of Science and ICT)
- 2017. 2. Selected for 'MS Azure ExpressRoute' location provider
 - 10. Established Japan PoP
- 2018.10. Selected for 'NBP(Naver Business Platform) Cloud Connect' location provider
 - 12. Launched 'IBM Direct Link' service
 - 12. Awarded 'Youth-Friendly Small Giants 2019' from Ministry of Employment and Labor
- 2019. 1. Launched 'Tencent Direct Connect' service
 - 8. Launched 'Oracle Fast Connect' service

Management Performance

KINX has been growing steadily based on IX and IDC services. In the last five years as of 2019, the average annual growth rate of sales was 10.3% and the average operating margin was 20.6%. In 2018, the operating margin and net profit ratio has increased to over 20% each. This is mainly due to the increase in network traffic caused by overseas customers.

I. Company Overview

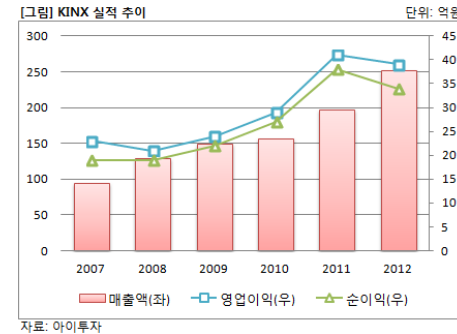

Sales(Growth rate)

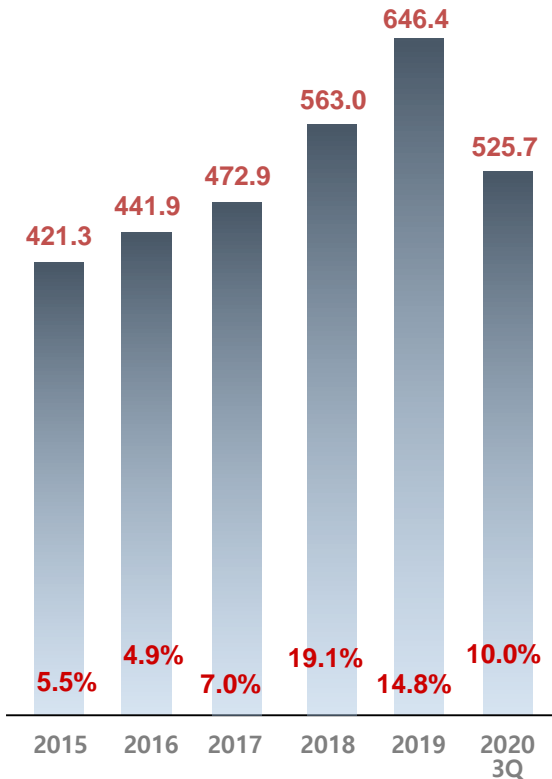

Operating margin(Rate)

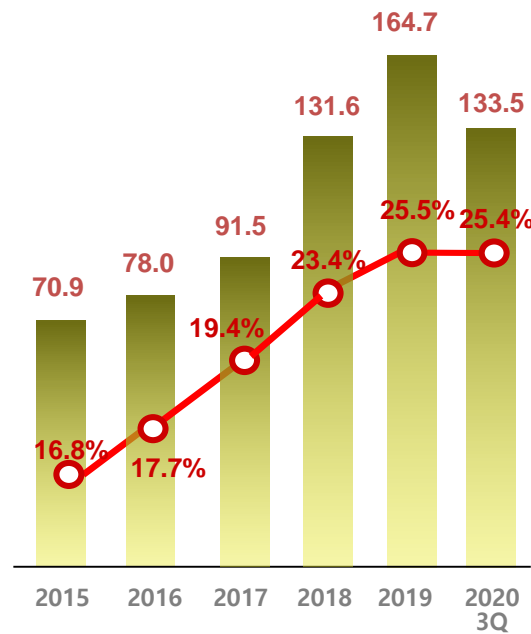

Net profit(Rate)

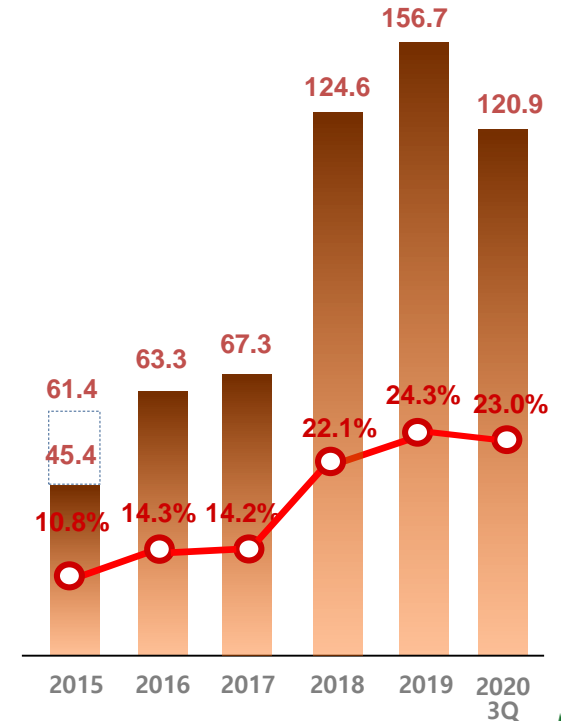

KINX is based on neutral IDC and the only neutral IX in Korea, and provides stable service not only for domestic but also for overseas customers with the best internet infrastructure technology. KINX is committed to its role as a business partner through consulting and suggestions to help customers succeed and improve efficiency, beyond just providing services.



Reliably provide the highest level of Internet infrastructure

KINX's IDC is equipped with state-of-the-art security devices, power facilities, disaster prevention facilities, and the best communications network system in Korea. Our professional engineers manage the infrastructure. We respond to the needs of our customers with 24-hour monitoring 365 days a year, and we are constantly working on effective and reliable network and infrastructure operations.



The only neutral IX in Korea

KINX IX is a Layer2 neutral IX (Internet Exchange) where customers set the interconnection policies. Since 2000, KINX has been providing economical and efficient internet traffic interconnection services to major ISP, CP, CSP, CDN operators, System Operators (SO), and government agencies at home and abroad. Traffic through KINX IX is constantly growing.



Business Success Partners for Internet operators

KINX offers customized, open, and integrated services tailored to your business. We provide the optimal operating environment, rack conditions, management capabilities, and reliable network infrastructure for customers who demand high-quality Internet infrastructure environments. We also provide the best conditions and the best service for business flexibility and cost reduction of domestic and foreign customers.

“As a neutral Internet infrastructure service company, we contribute to maximizing customer value and enhancing the benefits of Internet users.”

Open services

We are a company with the ability to meet a variety of needs without being tied to specific providers or subject to policy restrictions.

Customized services

We are a company with the capability to provide the best solution for the customer's characteristics, environment and various needs.

Integrated services

We are a company with the capacity to efficiently and reliably deliver all of its infrastructure, from resource procurement to operations and expansion.



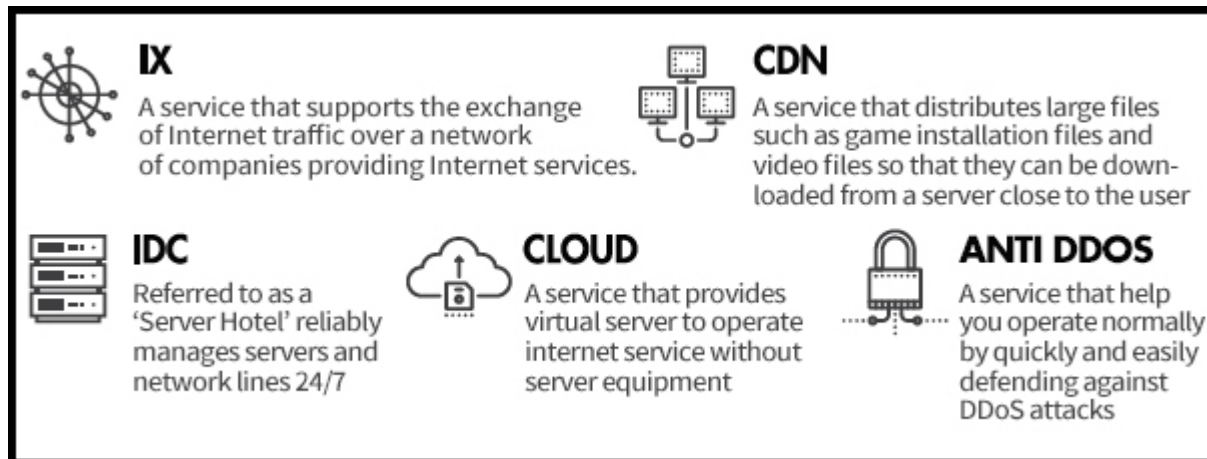
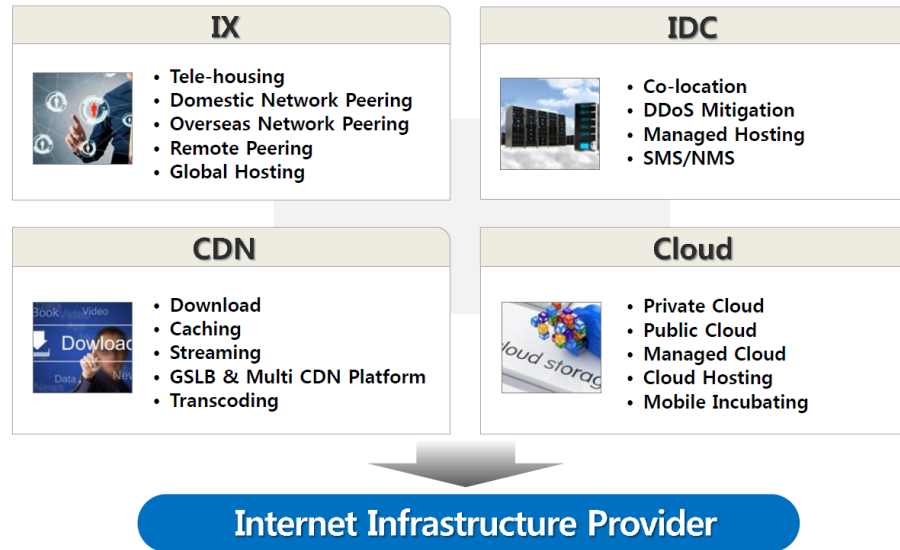

Customer Type by Service

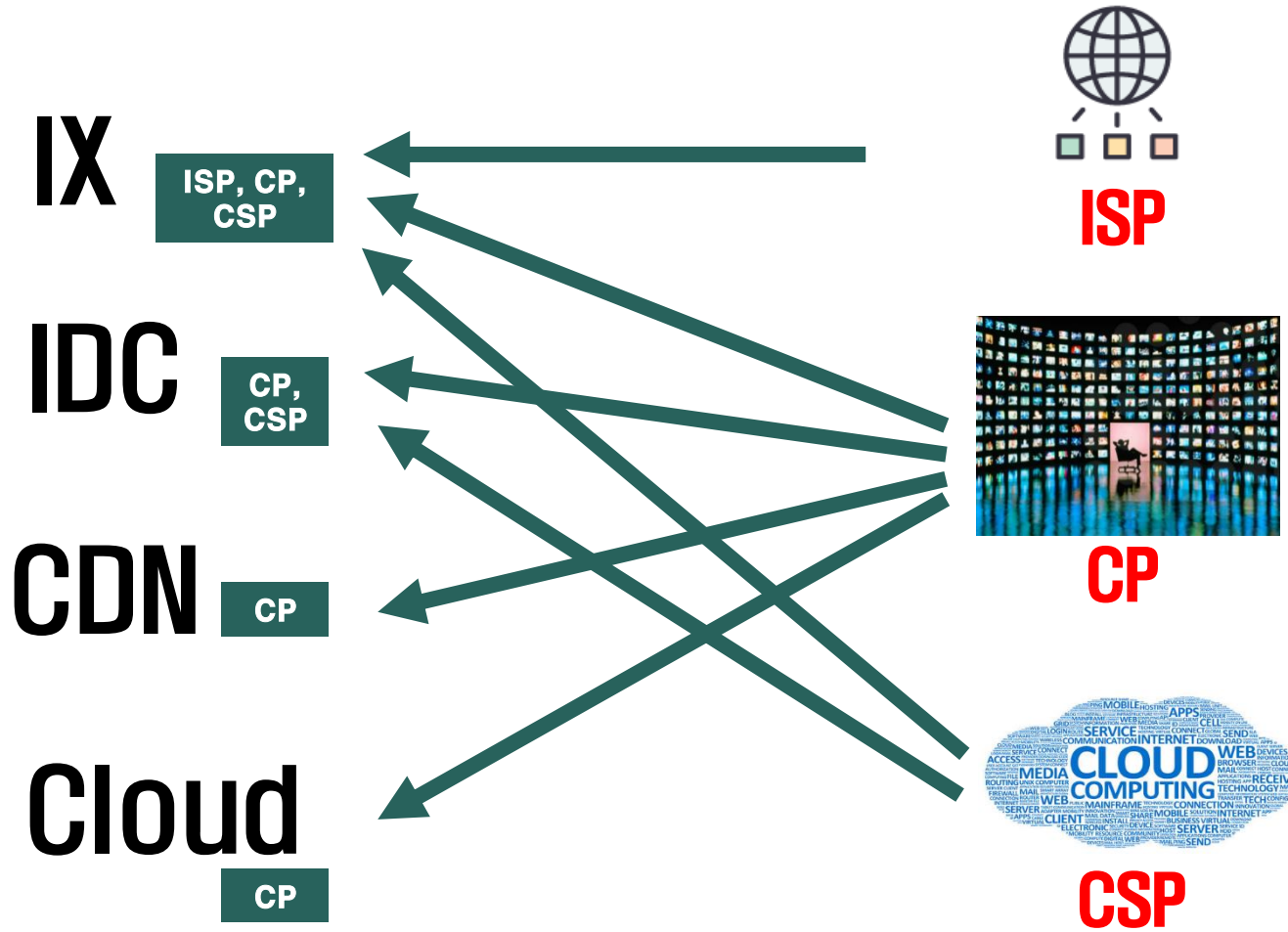

Service Category	Share of sales (100% in total) <small>*approximately</small>	Sales/Cost Factor
IDC	80%	Rack power consumption, Network(Traffic)
IX	13%	Network (Traffic) *Port charge
CDN	5%	Contents capacity (storage), Network (Traffic)
Cloud	2%	Resource usage (VM), Network(Traffic)

□ The Background and Concept of IX (Internet eXchange)

IX is an interconnecting system that is located **between the Internet network of ISPs(Internet Service Provider) that provide Internet lines to homes and businesses and the Internet network of other ISPs, to facilitate connection between networks. Large CPs that deliver relatively large amounts of content can be interconnected to IX to efficiently transfer large amounts of content to ISPs and improve transmission quality.** There are four IXPs (IX Providers) in Korea, **KINX, KT, LGU + and SKBB**, and the major ISPs are already interconnected. As a result, **new IXPs need higher interconnection efficiency to enter the market.**

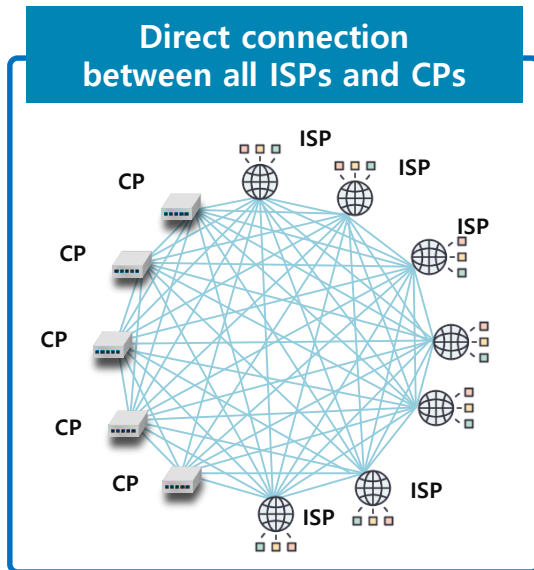

High cost, inefficiency

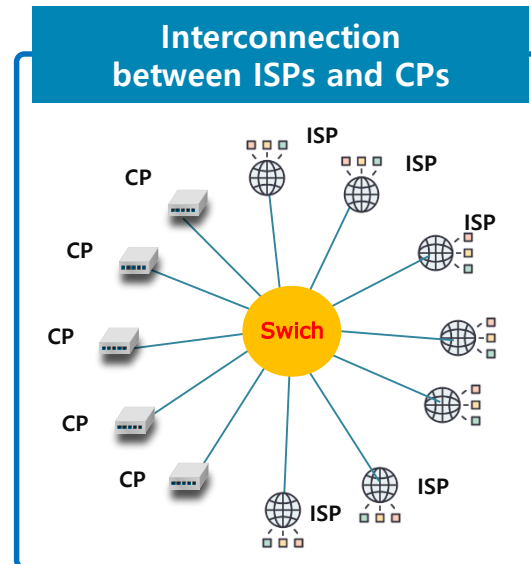
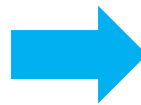

Low cost, high efficiency



▲ Switch Device

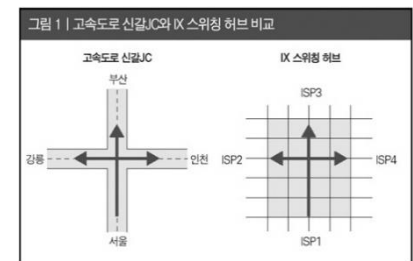

IX (Internet eXchange) Service

□ Comparison of KINX IX and Telco IX

KINX is the only L2 based neutral IX provider in Korea which **the customer determines the interconnection policy** such as interconnection quantity, interconnection route, etc. In addition, **KINX IX guarantees zero settlement between customers in traffic exchange**. KINX IX operates L2-based Neutral IX in foreign countries, and overseas customers prefer KINX IX among domestic IX due to the characteristics of this neutral service.

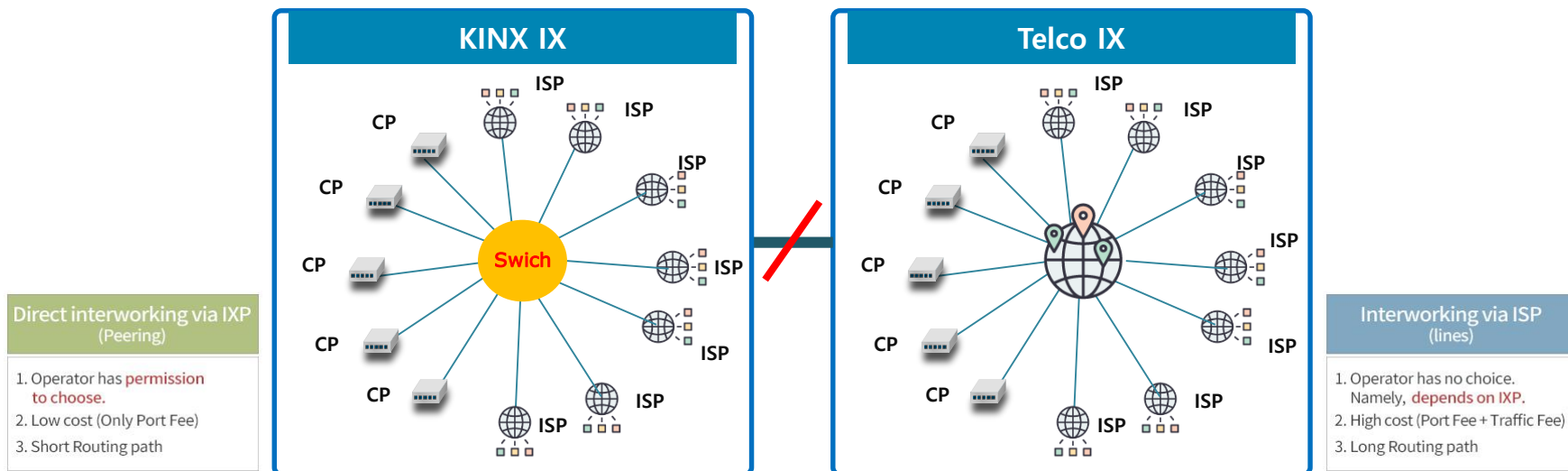

IXs operated by Korean major Telcos (KT, LGU +, SKB) only provides interconnections by utilizing their own network. The customer must use a specific Telco's network to interconnect, and the interconnection policy such as the interconnection path is determined by the Telco's router (Layer 3) policy. Therefore, the customer has no right to decide the paths that they would like to choose when they join those Telco IX.

IX (Internet eXchange) Service

□ Our Major ISP Customers_MSO

Since the IX service generates revenue through the traffic interconnection, it is possible to estimate the amount of interconnection based on the number of Internet users connected to the network, which is an important variable for the flow of Internet traffic. **The number of high-speed Internet subscribers owned by MSO (Multiple System Operator), a key customer of KINX, is about 3.1 million, which is 15% of all high-speed Internet subscribers. Considering other corporate subscribers, more than 15% of subscribers use KINX Internet eXchange through high-speed internet service providers every day.**

Current Status of Internet Subscribers in Korea

구분	2012.12월	2013.12월	2014.12월	2015.12월	2016.12월
KT	8,036,639	8,066,628	8,129,482	8,328,419	8,516,496
SK브로드밴드	3,068,041	2,842,115	2,749,600	2,691,735	2,672,905
SKT(재판매)	1,326,082	1,726,990	2,060,893	2,344,322	2,534,590
LG U+	2,743,151	2,928,157	3,014,196	3,483,244	3,611,199
종합 유선	2,960,554	3,060,328	3,157,512	3,110,211	3,160,330
기 타	118,194	113,296	87,251	66,488	60,163
합 계	18,252,861	18,737,514	19,198,934	20,024,419	20,555,683

구분	2017.12월	2018.12월	2019.1월	2019.2월
KT	8,758,425	8,729,383	8,745,112	8,756,242
SK브로드밴드	2,752,693	2,553,540	2,556,135	2,558,565
SKT(재판매)	2,686,579	2,851,326	2,865,568	2,877,965
LG U+	3,815,473	4,021,575	4,044,552	4,069,831
종합 유선	3,162,583	3,113,687	3,100,883	3,098,217
기 타	20,165	16,347	17,679	17,674
합 계	21,195,918	21,285,858	21,329,929	21,378,494

Source: Ministry of Science and ICT Homepage, Statistical data, Feb. 2019

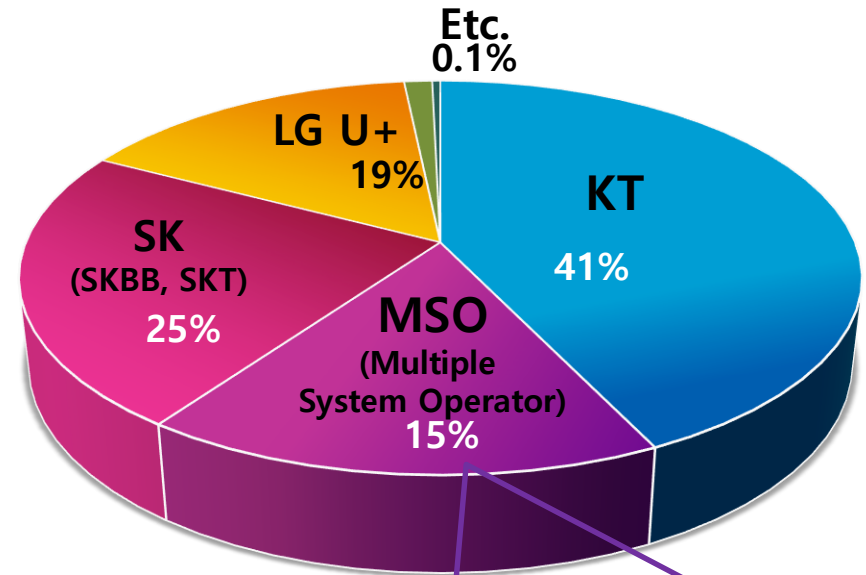

IX (Internet eXchange) Service

III. Service Description

□ Status of IX Peering Members

Status of KINX IX peering members

Domestic ISP sector (MSO/SO)

Domestic other ISP sector

Domestic and overseas CP sector

Overseas ISP sector

※ Due to non-disclosure agreements (NDAs), private key CP customers are excluded.

※ The detailed KINX IX peers : <https://www.peeringdb.com/ix/52>

Public Institutions & Others

공공기관 & 기타

			
---	---	---	---

IX (Internet eXchange) Service

III. Service Description

□ IX expansion

We have established a network base (PoP) connected to domestic IX and dedicated submarine cable overseas to reduce existing international line fees. In addition, we are promoting the expansion of the IX network to provide domestic and overseas ISPs and CPs with domestic and overseas network connections.

We established our PoP in **Hong Kong** in April 2013 and **Japan** in October 2017, strengthening our traffic expansion strategy by attracting additional overseas ISPs and CPs to join our IX.

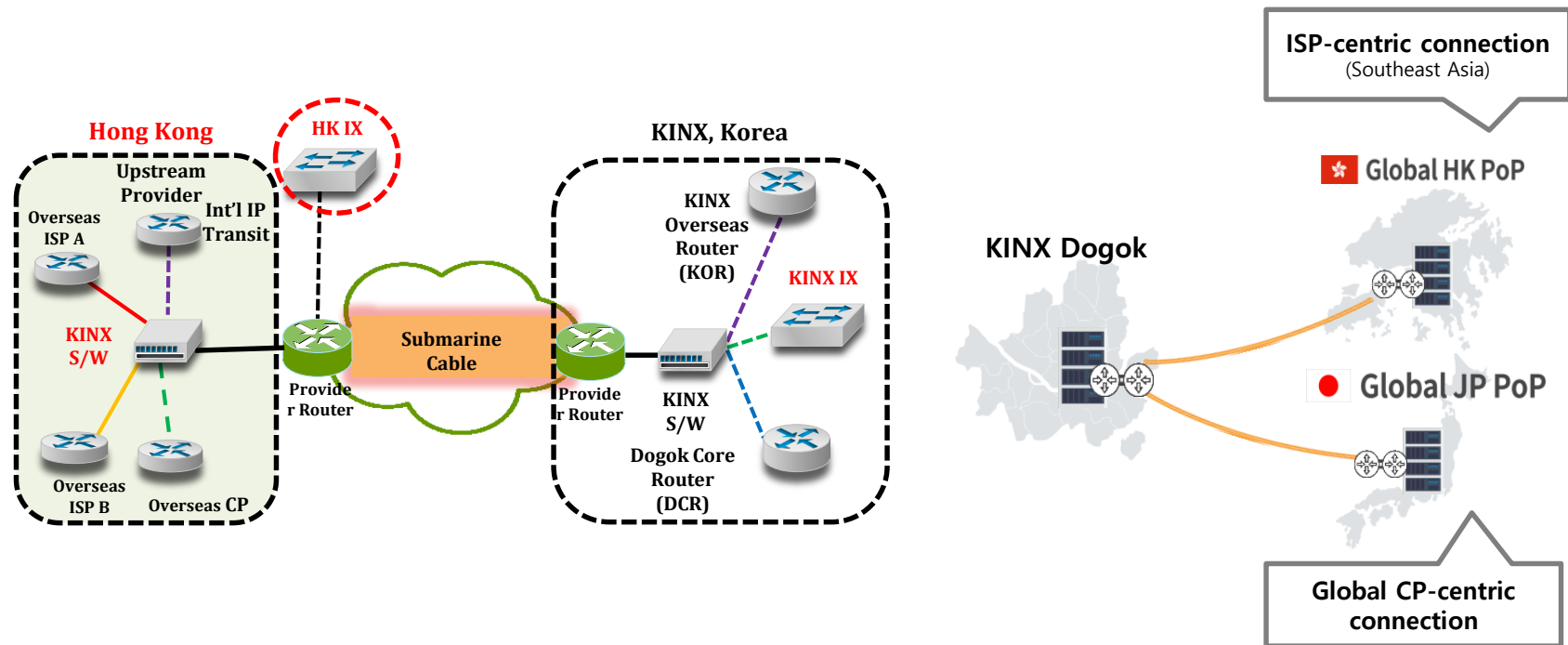

□ What is Internet Data Center?



What is IDC?

IDC(Internet Data Center) is **a kind of special space that has built an infrastructure environment for the smooth operation of computing equipment such as servers**, and is sometimes compared to a **'server hotel'**. IDC has the following facilities. **Rack space** for servers, large scale power faucet to power computerized equipment, **electrical installations**, such as UPS devices, to ensure that the power supply is not interrupted for even 1 second, **constant temperature and humidity facility** to prevent obstacles caused by heat generation of computerized equipment, various **security / disaster prevention facilities**, 24-hour **monitoring system**, **large-scale communication lines and line facilities** for Internet communication, etc.

What is co-location?

Co-location is a service that **manages your server 24 hours a day, 365 days a year in the optimal environment of the data center**. It is distinct from server hosting, where customers rent a server. Server operation in co-location is done by the customer, and IDC provides infrastructure services such as high speed networks, dedicated spaces, and control services. In addition, customers can receive various additional services such as backup, security and monitoring according to their needs.

The co-location service fee is basically determined by the **necessary electric power or use of electricity of the computer equipment such as the rack** where the server will be installed and the server to install, and **the circuit bandwidth for Internet communication**. The same is true for cost elements.

IDC(Internet Data Center) Service

□ KINX IDC_Neutral IDC

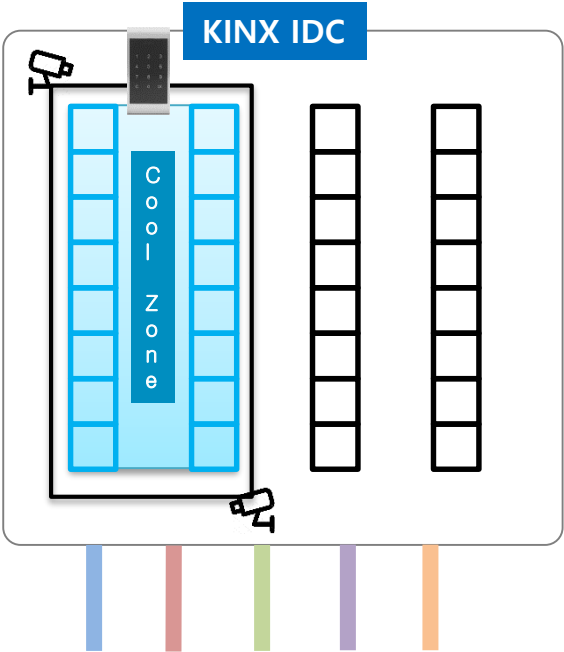

VS

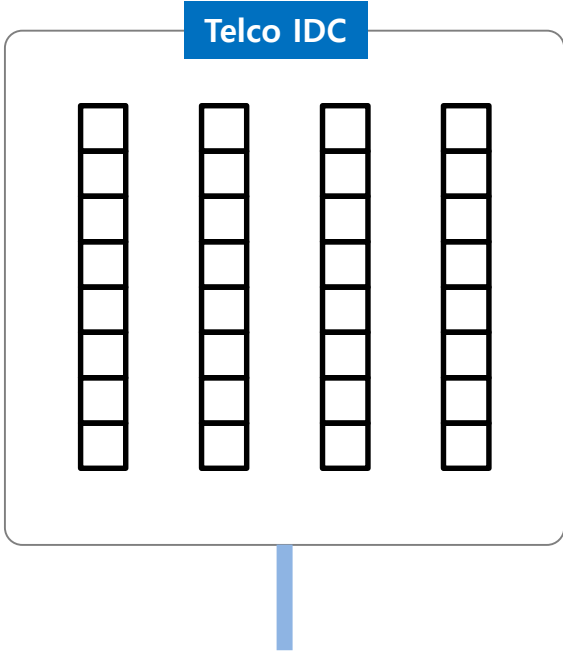

1. Various rack environments can be configured according to customer's needs or policies.
2. Leading in the network line(circuit) of various line providers
 - Ensure customer's line(circuit) selection and line cost reduction
 - Line duplication
3. Directly managed and operated by our technical staff

→ Tailored to customer's policy

1. Configure rack environment according to Telco's IDC policy
2. Only leading in the network line of corresponding Telco
3. In general, IDC management personnel are outsourced because of standardized

→ Tailored to Telco's policy

IDC(Internet Data Center) Service

III. Service Description

□ KINX IDC_Synergy with IX

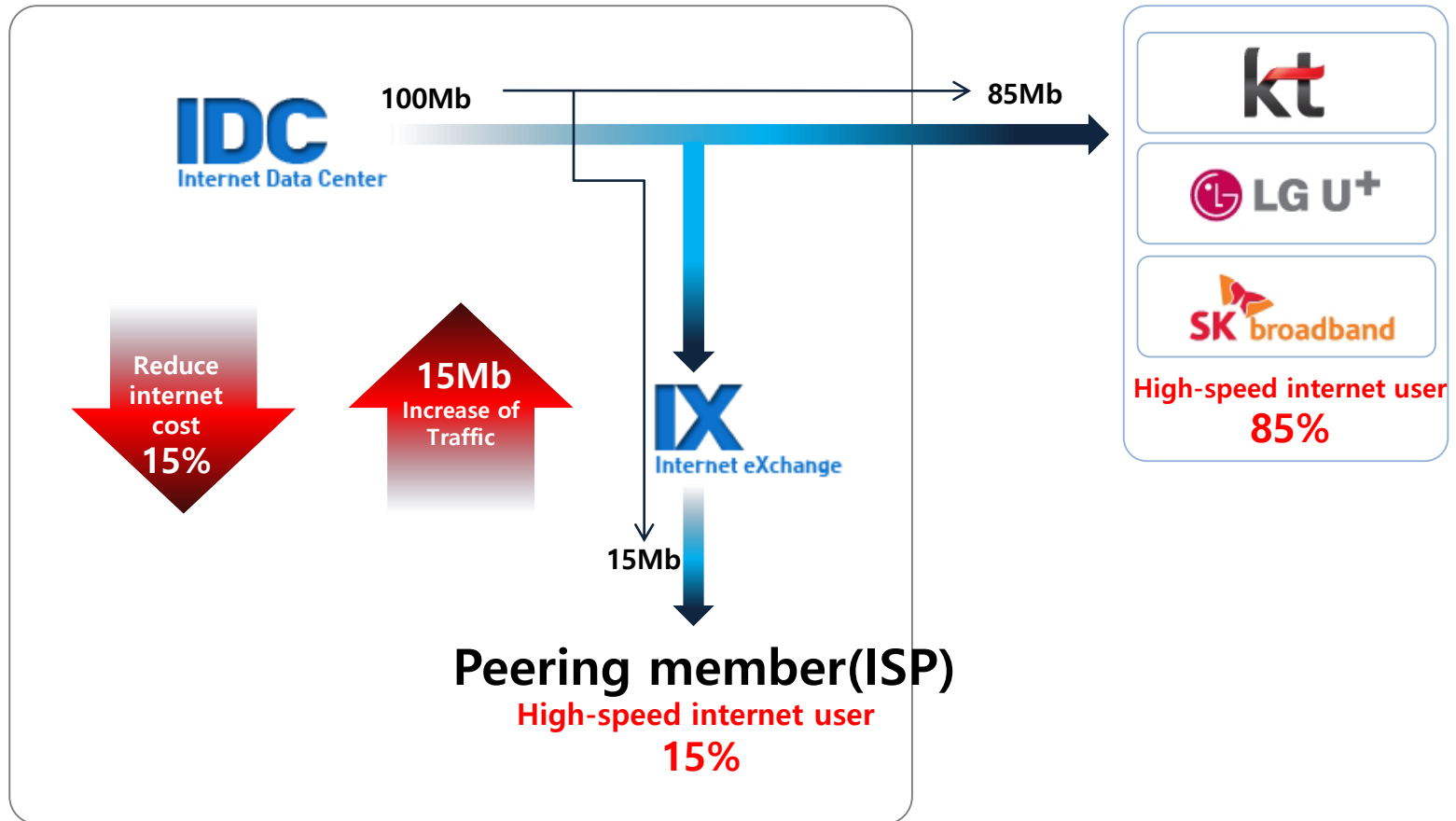

IDC(Internet Data Center) Service

III. Service Description

□ KINX IDC_Status by Region

KINX established IDC in six metropolitan areas centered around Dogok center to **secure network connectivity between each center**. Every center provides **stable IX, IDC (co-location), Cloud, and CDN services**. KINX is also preparing to **expand IDC** based on customer demand. **Overseas, we have IX PoP in Hong Kong and Japan to secure domestic and overseas connectivity**. We will continue to **expand our overseas network** to meet demand.

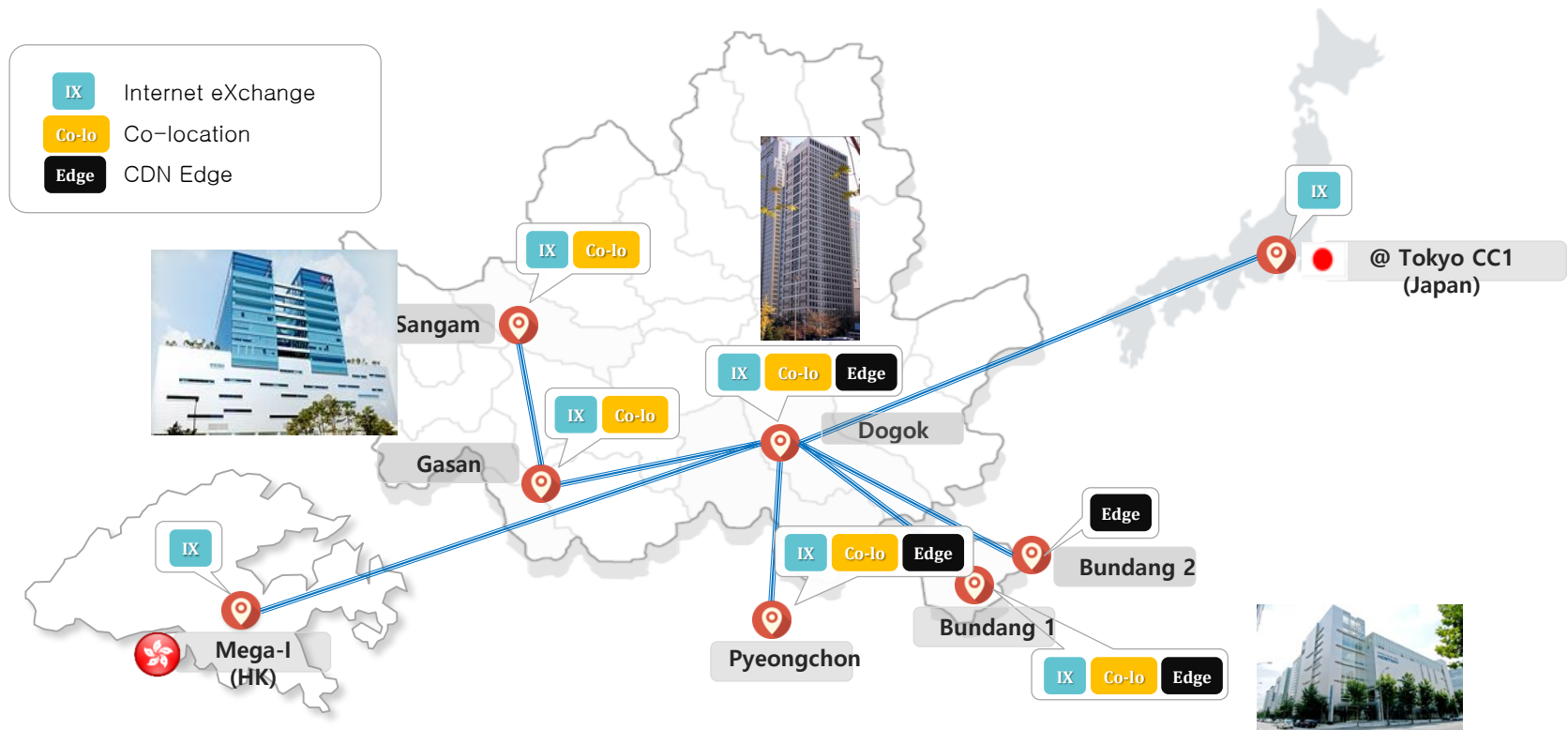

□ IDC Status in Korea

Soaring Domestic Data Center Demand, Why?

2017.06.28 08:30:50 / 백지영 ivp@ddaily.co.kr



▲사진은 LG유플러스의 평촌 메가센터

[디지털데일리 백지영기자] 클라우드 서비스, 인공지능(AI) 등의 신사업 확대에 국내 데이터센터(IDC) 수요가 폭증하고 있다. 때문에 기존에 IDC를 보유하고 있는 통신사나 인터넷 서비스 사업자는 물론, 국내에 진출한 해외 기업이나 국내 소프트웨어(SW) 기업도 IDC를 늘리고 있는 상황이다. 한국IT서비스산업협회(ITSA)에 따르면, 2016년 기준 국내 IDC 숫자는 145개다.

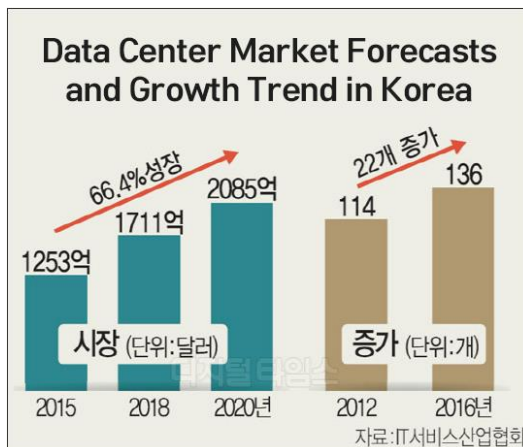

- Source: Evolving Data Center (Digital times, Aug. 22, 2017)

<표 3-2> Main Fields for Domestic Data Center Business

항목	비율
IT서비스	45.8%
통신사업자	24.1%
정부 및 공공	20.5%
금융 및 증권	4.8%
연구소	2.4%
교육 및 기타	2.4%
합계	100%

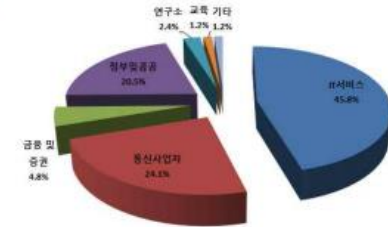

<표 3-5> Domestic Data Center Service Contents

항목	비율
자사관련	24.1%
상면임대	22.4%
매니지드(운영관리)	19.5%
백업 서비스	12.6%
서버호스팅	10.9%
클라우드	10.3%
합계	100%

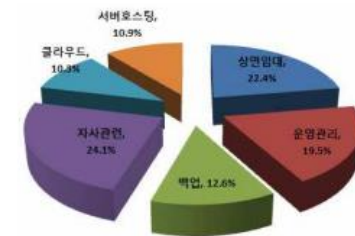

* 복수응답

- Source: A Study on Creating a Foundation for Fostering the Data Center Industry (Ministry of Science and ICT, Oct. 2015)

IDC(Internet Data Center) Service

III. Service Description

□ Expansion of Network Services_CDC

China Direct Connect (CDC) is a network service that connects directly from the KINX Gasan Center to a major Chinese base through China Telecom's high-quality next generation network (CN2). It was the first service in the industry. (Aug, 2015) **Customers can transfer their content from Korea to China through a high-quality network through CDC.**

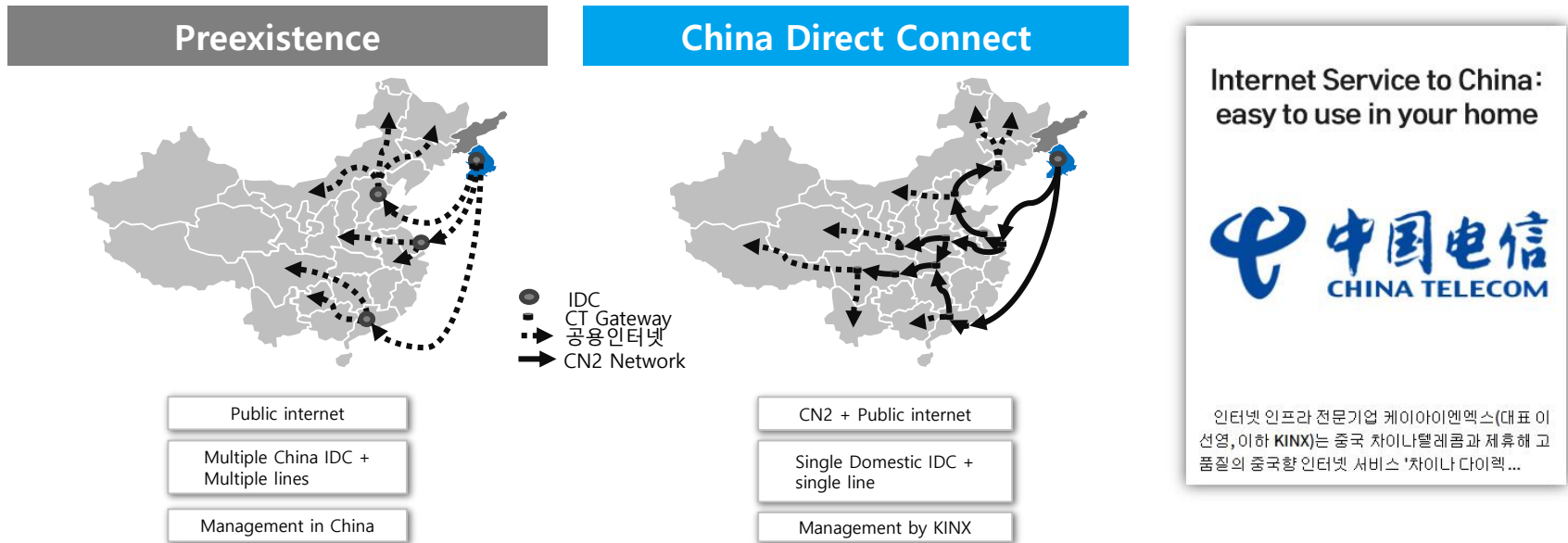

Internet Service to China:
easy to use in your home

中国电信
CHINA TELECOM

인터넷 인프라 전문기업 케이아이엔엑스(대표 이선영, 이하 KINX)는 중국 차이나텔레콤과 제휴해 고품질의 중국향 인터넷 서비스 '차이나 다이렉트...'

IDC(Internet Data Center) Service

III. Service Description

□ Expansion of Network Services **ADC**

Amazon Direct Connect (ADC) is an AWS network service that enables Amazon's cloud (AWS) users to quickly use AWS over a dedicated line, and is intended to improve high quality Internet network communication. The hub of a dedicated network line for ADC services is located in KINX, a neutral IDC operator. (Jan. 2016) KINX utilizes the ADC Zone (network point) to **provide our IDC services and network connectivity to CP customers who want to use ADC.**

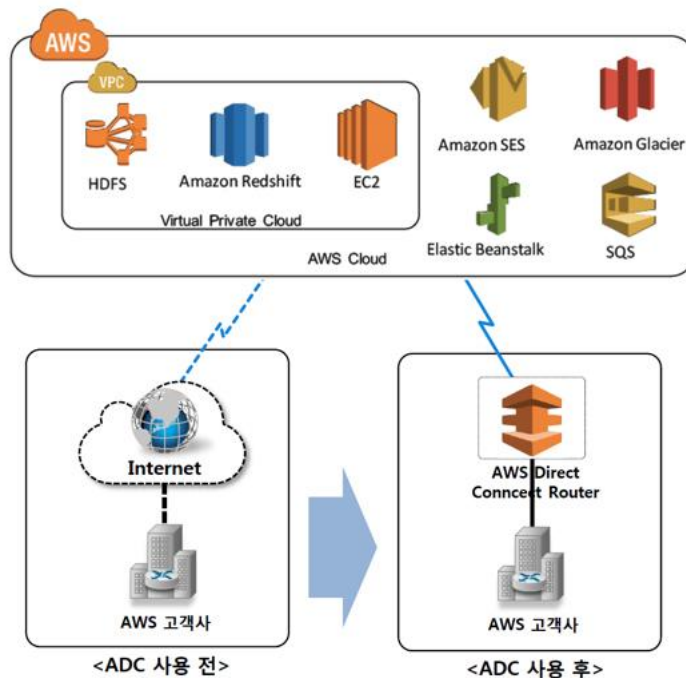

01 Located in the same IDC as ADC Zone (Customers using KINK IDC)

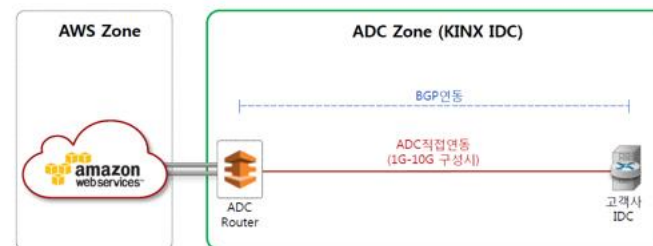

02 Located in Remote IDC (Other IDC/Customer IDC)

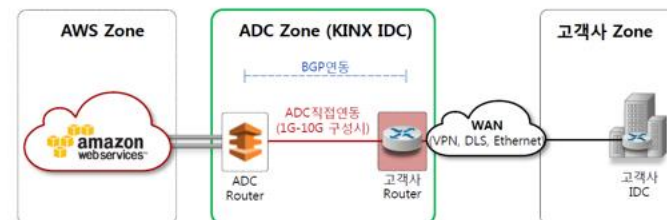

□ Expansion of Network Services_ **Cloud Hub**

- **Cloud eXchange (CX) connects** to various clouds in one line
- **Cross-Connect** to connect with major ISPs and additional service providers at home and abroad
- **IDC environment** optimized for hybrid cloud and multi cloud
- **Provides the most number of private access to major CSPs in Korea**

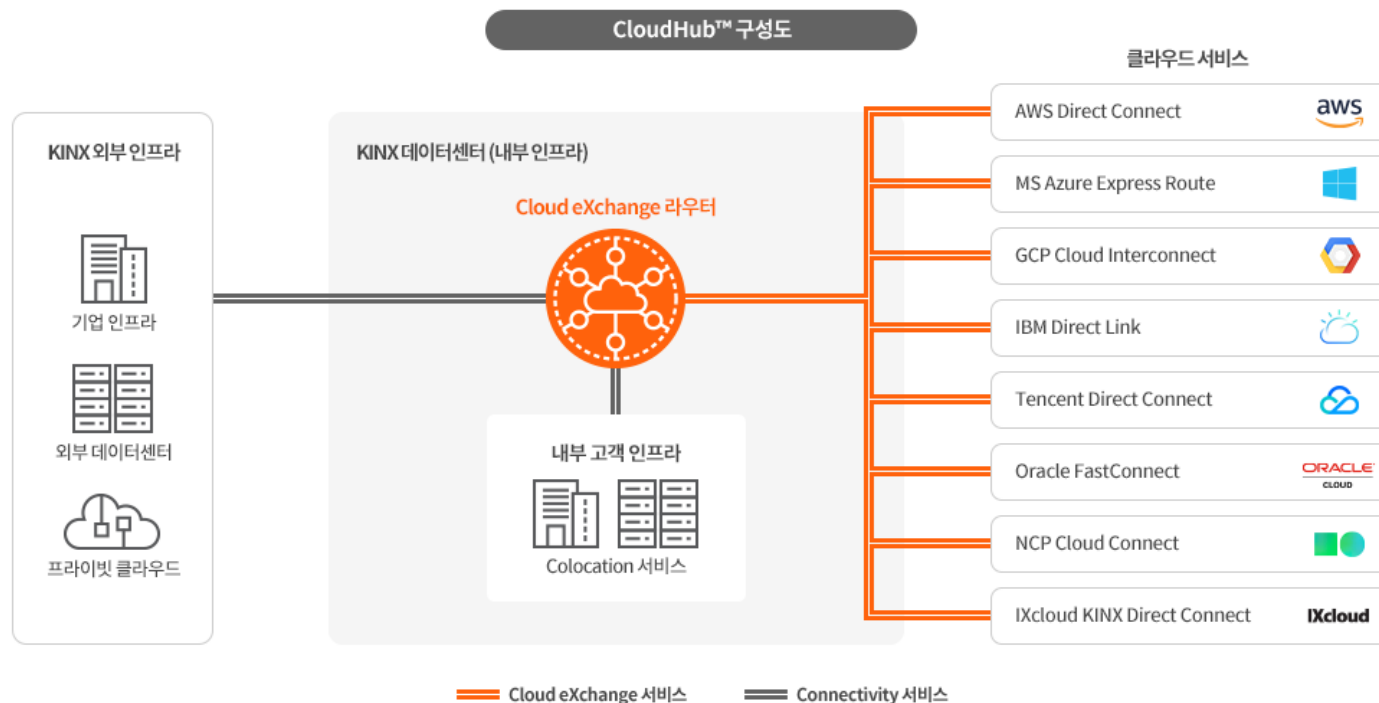

CDN(Content Delivery Network) Service

CDN service does not provide content directly to the content user from the origin server of the customer (CP), but distributes the content to multiple edge servers so that the content can be delivered quickly and smoothly without interruption or congestion.

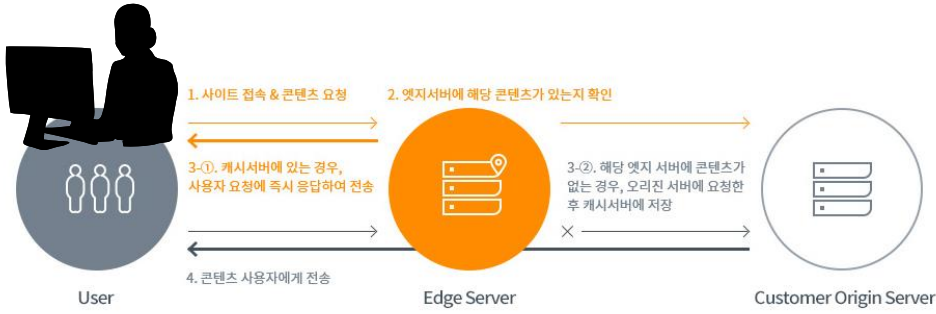

+ CP (CONTENTS PROVIDER)

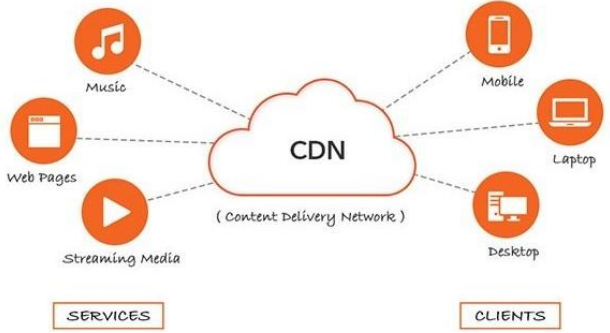

“ KINXCDN can deliver contents through CDN PoP (edge server) located in Korea as well as worldwide through partnership with global CDN operators. ”



Cloud service is a **server virtualization** that allows customers to select a server, storage, network, etc. of desired specifications from the Web without purchasing a physical server, and then request a cloud service so that they can do what they want on the Web just like using a real server. It's **economical** because you pay only as much as you use during the desired service period. **KINX accepts existing customers** who want to add or transform resources in the cloud environment **with IXcloud**, and **acquires new cloud customers (CP)**.



What is IXcloud?



IXcloud is a Public Cloud that started commercial service in September 2012. IXcloud is based on OpenStack, an easy-to-deploy, scalable, open source cloud computing platform of any size. Participated in more than 180 companies around the world, the platform provides the same experience as software used in large commercial cloud services such as AWS (Amazon). KINX provides stable cloud services based on large-scale network, infrastructure, and system operation technology.

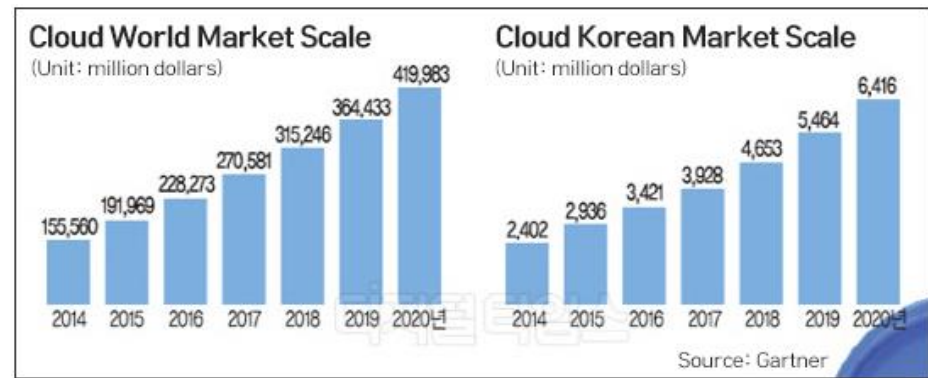

1. Continued increase in Internet traffic

Domestic and overseas Internet traffic is on the rise for the following reasons.

- Increasing the number and capacity of Internet content
- New Internet-enabled technologies and businesses, including cloud, IoT, VR, blockchain and artificial intelligence, related to the Fourth Industrial Revolution
- Improved transmission speed such as optical LAN and 5G
- Increasing number of devices connected to the Internet such as smartphones, tablet PCs, and TVs
- The growth rate of mobile traffic is very fast, but the amount of traffic is still small compared to the wired.



IP Traffic Growth Trends in Korea

IP Traffic in 2019 expected to grow twice compared to 2014

(단위: 엑시바이트/월)

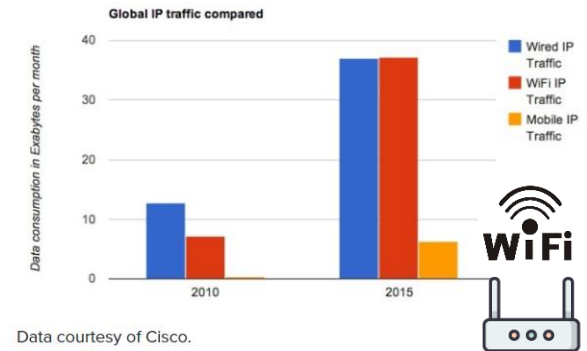
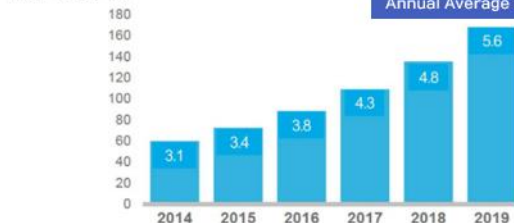

Global IP Traffic Growth / Top-Line

Global IP Traffic will increase 3-Fold from 2014-2019

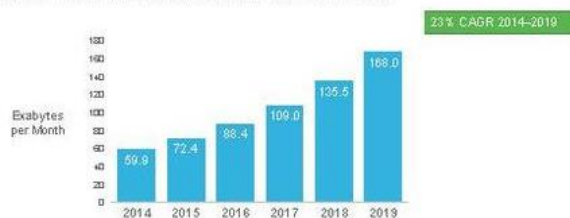

Global Mobile Traffic Growth Prospect

57% CAGR 2014-2019



▲ 월간 모바일 데이터 트래픽 성장 추세 (출처: 시스코 비주얼 네트워크 인덱스 글로벌 모바일 데이터 트래픽 전망 5쪽)

2. IDC and network demand growth trend

IDC demand is on the rise due to the increase in CSP(Cloud Service Provider) and new Internet services such as IoT, VR, blockchain, and artificial intelligence. In addition, global CPs (Contents Providers) are expanding their presence in Korea and expanding their services. Domestic CP operators are not only limited to the domestic market but are expanding to global services, and domestic demand for overseas contents is also increasing. Therefore, overseas network traffic and connection demand are also on the rise.

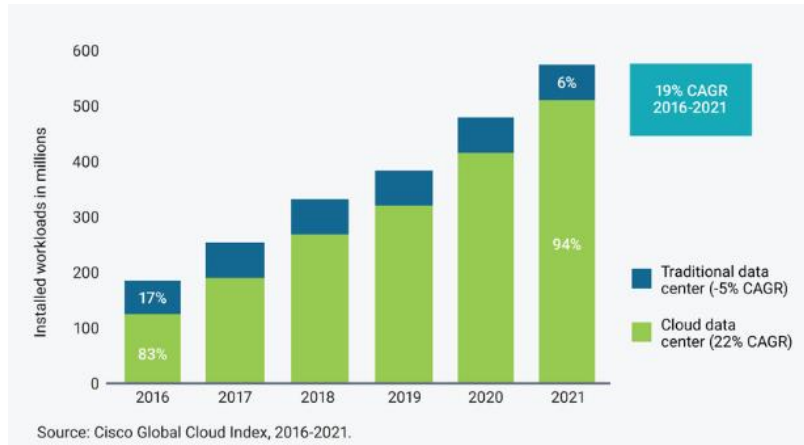

The Countries With the Fastest Internet

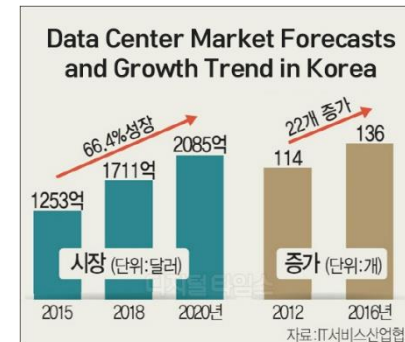
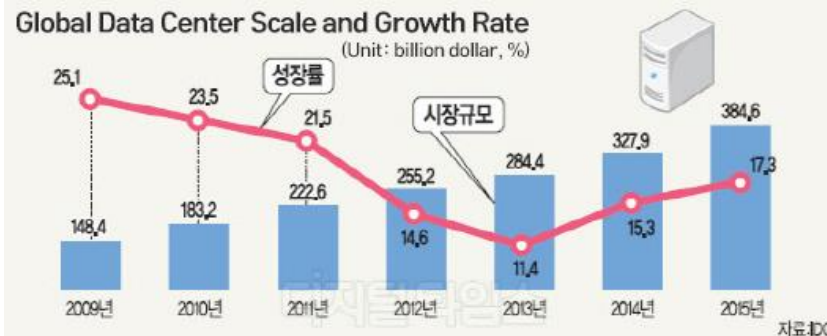
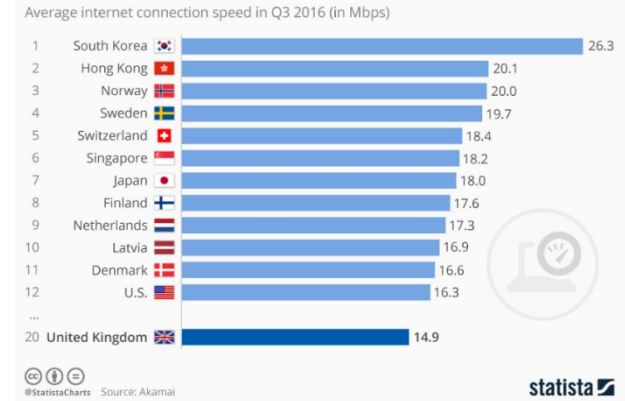

KINX's business strategy direction is to expand 'Connectivity' and 'Infrastructure' services.

□ Expansion of Connectivity

1. Expanding relay network services between Internet providers such as ISP, CP, CSP
2. Expansion of content delivery network connecting domestic and overseas
3. Expand connectivity between various infrastructure services

□ Expansion of Infrastructure

1. Continuous investment to provide the highest level of stable infrastructure
2. Increasing investment in infrastructure such as IDC and network as demand increases
3. Expand infrastructure service model to respond quickly to market changes
4. Expansion of Global Infrastructure Services

□ Expected Effect

1. Increase in domestic and international Internet traffic flowing through KINX
2. Increasing number of domestic and international customers using KINX's infrastructure



▲ Gwacheon new headquarters and IDC bird's-eye view
(Scheduled to be completed in 2022 4Q ~ 2023 1Q)

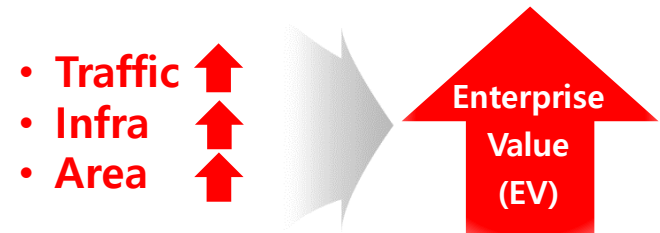



Q&A

KINX

© KINX Inc. All Rights Reserved.